

# NBC-M8MSD/ 5,0-93C/R4AC - Network cable



1423713

<https://www.phoenixcontact.com/us/products/1423713>

Please be informed that the data shown in this PDF document is generated from our online catalog. Please find the complete data in the user documentation. Our general terms of use for downloads are valid.



Network cable, PROFINET CAT5 (100 Mbps), EtherCAT<sup>®</sup> CAT5 (100 Mbps), 4-position halogen-free, shielded (Advanced Shielding Technology), Plug straight M8, coding: D / IP67, on Plug straight RJ45 / IP20, cable length: 5 m

## Commercial data

Item number	1423713
Packing unit	1 pc
Minimum order quantity	1 pc
Sales key	BF02
Product key	BF1BJI
Catalog page	Page 395 (C-2-2019)
GTIN	4055626569260
Weight per piece (including packing)	339.1 g
Weight per piece (excluding packing)	290.33 g
Customs tariff number	85444290
Country of origin	PL

## Technical data

### Notes

General	This product corresponds to the PROFINET Cabling and Interconnection Technology Guideline for PROFINET regulations, version 2.00, order no: 2.252, Chapter 8.2 Connectors for Outside Environment (Balanced cabling)
---------	--

### Product properties

Product type	Data cable preassembled
Sensor type	PROFINET
Number of positions	4
Application	Standard
No. of cable outlets	1
Shielded	yes
Coding	D

### Interfaces

Signal type/category	PROFINET CAT5 (IEC 11801), 100 Mbps
	EtherCAT® CAT5 (IEC 11801), 100 Mbps

### Signaling

Status display	No
Status display present	No

### Electrical properties

Nominal voltage $U_N$	48 V AC
	60 V DC
Nominal current $I_N$	1 A
Transmission medium	Copper

### Connector

#### Connection 1

Type	Plug straight M8 / IP67
Number of positions	4
Coding type	D (Data)
Shielded	yes
Handle color	black
Material	CuSn (Contact)
	Ni/Au (Contact surface)
	PA 6.6 (Contact carriers)
	TPU, hardly inflammable, self-extinguishing (Grip)
	Brass, nickel-plated (Screw connection)
Insertion/withdrawal cycles	≥ 100

# NBC-M8MSD/ 5,0-93C/R4AC - Network cable



1423713

<https://www.phoenixcontact.com/us/products/1423713>

Contact resistance	≤ 5 mΩ
Insulation resistance	≥ 100 MΩ
Tightening torque	0.2 Nm
Degree of protection	IP67
Ambient temperature (operation)	-25 °C ... 90 °C

## Connection 2

Type	Plug straight RJ45 / IP20
Number of positions	4 (8)
Handle color	black
Material	CuSn (Contact) Ni/Au (Contact surface) PA (Contact carriers) PA (Housing)
Insertion/withdrawal cycles	≥ 750
Degree of protection	IP20
Ambient temperature (operation)	-25 °C ... 80 °C

## Cable/line

Cable length	5 m
--------------	-----

## PROFINET drag chain CAT5 [93C]

Dimensional drawing	
Cable weight	61 kg/km
Number of positions	4
Shielded	yes
Cable type	PROFINET drag chain CAT5 [93C]
Conductor structure	1x4xAWG22/7, SF/TQ
Signal runtime	5.3 ns/m
Signal speed	0.66 c
Conductor structure signal line	7x 0.25 mm
AWG signal line	22
Conductor cross section	4x 0.34 mm <sup>2</sup>
Wire diameter incl. insulation	1.5 mm
External cable diameter	6.5 mm ±0.2 mm
Outer sheath, material	PUR
External sheath, color	green RAL 6018
Conductor material	Tin-plated Cu litz wires

# NBC-M8MSD/ 5,0-93C/R4AC - Network cable



1423713

<https://www.phoenixcontact.com/us/products/1423713>

Material wire insulation	PE
Single wire, color	white, yellow, blue, orange
Thickness, outer sheath	approx. 0.9 mm
Overall twist	Star quad
Optical shield covering	85 %
Insulation resistance	≥ 500 MΩ*km
Coupling resistance	≤ 20.00 mΩ/m (at 10 MHz)
Loop resistance	≤ 120.00 Ω/km
Wave impedance	100 Ω ±15 Ω (at 1 ... 100 MHz)
Nominal voltage, cable	600 V (UL rating)
Test voltage Core/Core	2000 V (50 Hz, 1 min.)
Test voltage Core/Shield	2000 V (50 Hz, 1 min.)
Minimum bending radius, fixed installation	5 x D
Minimum bending radius, flexible installation	7.5 x D
Smallest bending radius, fixed installation	33 mm
Smallest bending radius, movable installation	49 mm
Max. bending cycles	3000000
Tensile strength	≤ 150 N
Torsion force	± 30 °/m
Near end crosstalk attenuation (NEXT)	80 dB (with 1 MHz) 76 dB (at 4 MHz) 70 dB (at 10 MHz) 65 dB (at 16 MHz) 63 dB (at 20 MHz) 60 dB (at 31.25 MHz) 55 dB (at 62.5 MHz) 50 dB (at 100 MHz)
Shield attenuation	2.1 dB (with 1 MHz) 4 dB (at 4 MHz) 6.3 dB (at 10 MHz) 8 dB (at 16 MHz) 9 dB (at 20 MHz) 11.4 dB (at 31.25 MHz) 16.5 dB (at 62.5 MHz) 21.3 dB (at 100 MHz)
Halogen-free	yes
Flame resistance	according to IEC 60332-1-2
Resistance to oil	in accordance with DIN EN 60811-2-1
Other resistance	UV resistant
Special properties	Electrical properties in accordance with EN 50288-2-2
Ambient temperature (operation)	-40 °C ... 70 °C (cable, fixed installation) -40 °C ... 70 °C (Cable, flexible installation)
Ambient temperature (installation)	-20 °C ... 60 °C

# NBC-M8MSD/ 5,0-93C/R4AC - Network cable



1423713

<https://www.phoenixcontact.com/us/products/1423713>

## Environmental and real-life conditions

### Ambient conditions

Degree of protection	IP65 (M12 connector)
	IP67 (M12 connector)
	IP20 (RJ45 connector)
Ambient temperature (operation)	-25 °C ... 90 °C (M12 connector)
	-25 °C ... 80 °C (RJ45 connector)

## Standards and regulations

### M8

Standard designation	M8 connector
Standards/specifications	IEC 61076-2-114

# NBC-M8MSD/ 5,0-93C/R4AC - Network cable



1423713

<https://www.phoenixcontact.com/us/products/1423713>

## Drawings

Dimensional drawing

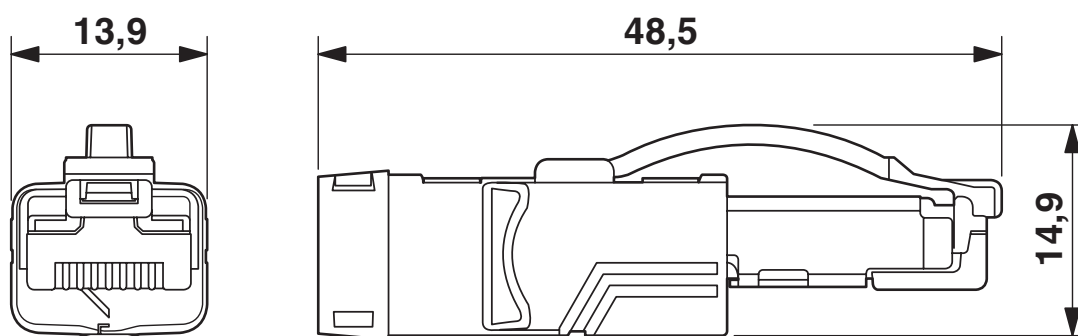

RJ45 connector, IP20

Schematic diagram



Connector pin assignment plug RJ45

Dimensional drawing

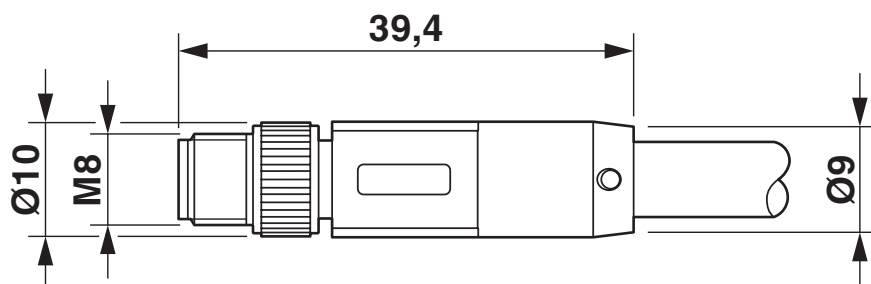

Plug M8 x 1, straight, shielded

1423713

<https://www.phoenixcontact.com/us/products/1423713>

Schematic diagram

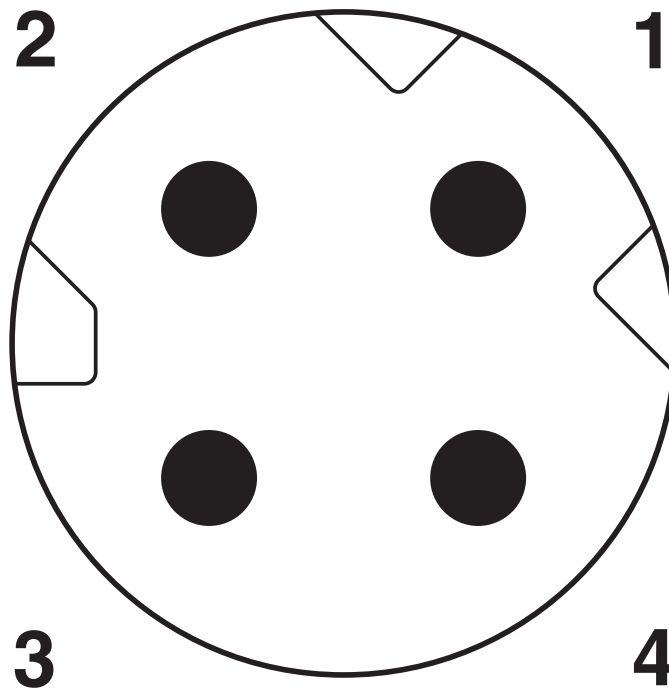

Pin assignment M8 male connector, 4-pos., D-coded, view of pin side

Circuit diagram

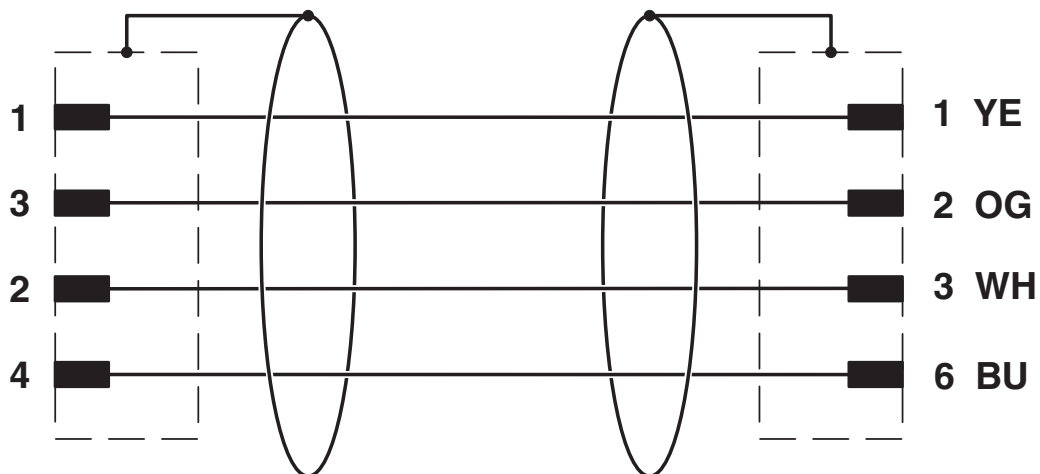

# NBC-M8MSD/ 5,0-93C/R4AC - Network cable





1423713

<https://www.phoenixcontact.com/us/products/1423713>

## Approvals

To download certificates, visit the product detail page: <https://www.phoenixcontact.com/us/products/1423713>

 <b>UL Listed</b> Approval ID: E335024				
	Nominal voltage $U_N$	Nominal current $I_N$	Cross section AWG	Cross section $\text{mm}^2$
	30 V	0.5 A	-	-

 <b>cUL Listed</b> Approval ID: E335024				
	Nominal voltage $U_N$	Nominal current $I_N$	Cross section AWG	Cross section $\text{mm}^2$
	30 V	0.5 A	-	-

<b>cULus Listed</b>				
---------------------	--	--	--	--

# NBC-M8MSD/ 5,0-93C/R4AC - Network cable



1423713

<https://www.phoenixcontact.com/us/products/1423713>

## Classifications

### ECLASS

ECLASS-11.0	27060307
ECLASS-12.0	27060307
ECLASS-13.0	27060307

### ETIM

ETIM 9.0	EC001855
----------	----------

### UNSPSC

UNSPSC 21.0	26121600
-------------	----------

# NBC-M8MSD/ 5,0-93C/R4AC - Network cable



1423713

<https://www.phoenixcontact.com/us/products/1423713>

## Environmental product compliance

China RoHS	Environmentally friendly use period: unlimited = EFUP-e
	No hazardous substances above threshold values

Phoenix Contact 2024 © - all rights reserved  
<https://www.phoenixcontact.com>

Phoenix Contact USA  
586 Fulling Mill Road  
Middletown, PA 17057, United States  
(+717) 944-1300  
[info@phoenixcon.com](mailto:info@phoenixcon.com)